

# PRODUCT INSTRUCTION MANUAL

3-18x56 PRO

noxar

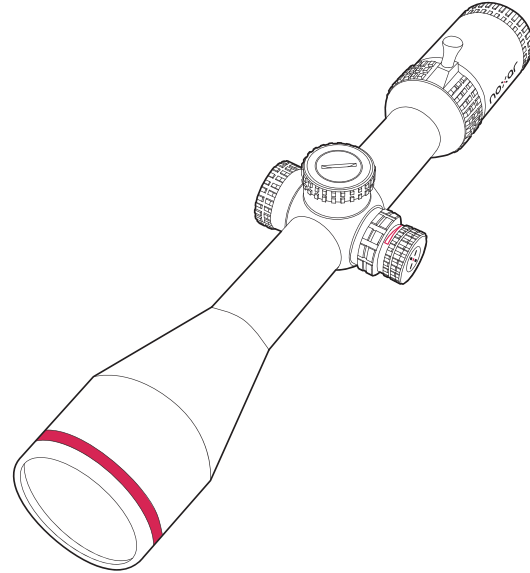

noxar

---

# CONTENTS

<b>1-OVERVIEW</b> .....	<b>01</b>
<b>2-ACCESSORIES</b> .....	<b>01</b>
<b>3-DESCRIPTION</b> .....	<b>02</b>
<b>4-SPECIFICATIONS</b> .....	<b>03</b>
<b>5-RETICLE</b> .....	<b>04</b>
<b>6-MOUNTING YOUR SCOPE</b> .....	<b>05</b>
<b>7-FOCUSING YOUR SCOPE</b> .....	<b>06</b>
<b>8-ADJUSTABLE PARALLAX KNOB</b> .....	<b>06</b>
<b>9-WINDAGE AND ELEVATION ADJUSTMENT TURRETS</b> .....	<b>07</b>
<b>10-ZEROING YOUR SCOPE</b> .....	<b>08</b>
<b>11-BATTERY</b> .....	<b>08</b>
<b>12-CARE AND MAINTENANCE</b> .....	<b>09</b>
<b>13-BALLISTIC TURRET</b> .....	<b>09</b>

## 1 OVERVIEW

### PLEASE READ THE ENTIRE MANUAL

*Failure To Follow These Instructions And Procedures May Result In Injury Or Death.*

Always follow firearm safety rules as outlined by the firearms manufacturer. Keep this and all firearm related products locked and secured from children or other unauthorized users.

## 2 ACCESSORIES

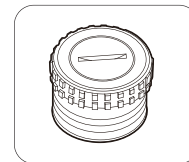
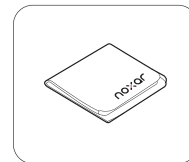
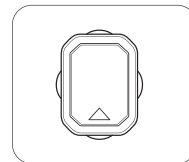
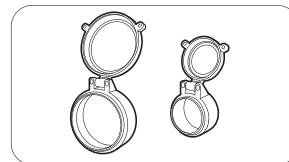
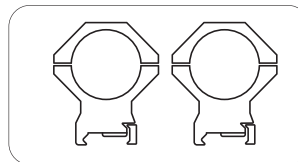
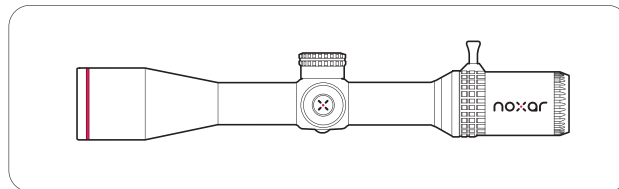

## 3

## PRODUCT DESCRIPTION

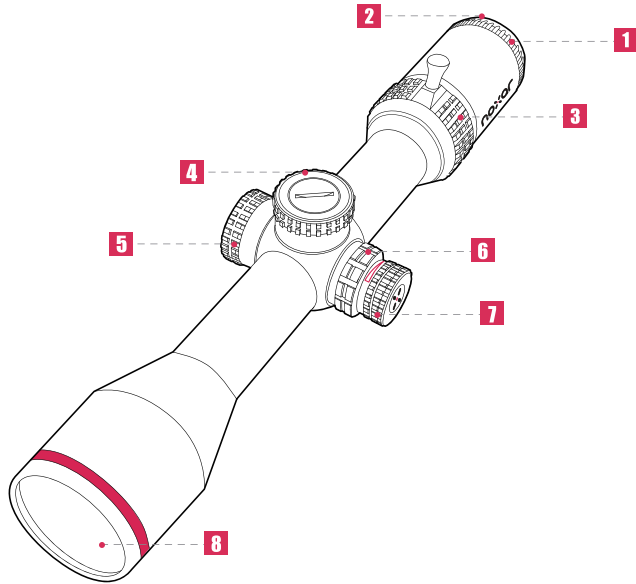

- **1** Focus Ring
- **2** Ocular Lens
- **3** Magnification Ring
- **4** Elevation Adjustment
- **5** Windage Adjustment
- **6** Parallax Adjustment
- **7** Illumination
- **8** Objective Lens

## 4

## SPECIFICATIONS

Model	3-18x56 PRO
Magnification	3X-18X
Lens Diameter	56mm
Eyepiece Diameter	38,5mm
Coating	FMC
Tube Diameter	30mm
Lenght	379mm
Weight	775g
Shockproof	Yes
Waterproof	Yes
Fogproof	Yes
Reticle	Etched Reticle
Eye Relief	100mm
Exit Pupil	10,2-3,2mm
FOV	7,7°~1,3°
Diopter Adjustment	-2,5~+2,5
Parallaxsetting	10m~infinity

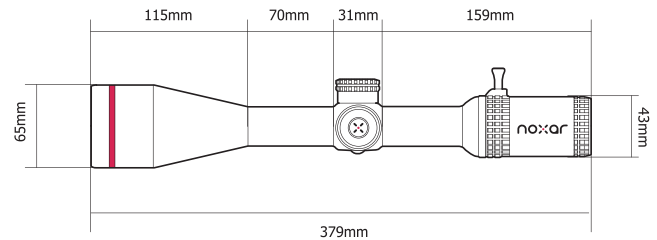

## 3-18x56 PRO Reticle

This reticle features red/green illumination, providing a clear aiming point in low-light conditions. The illumination brightness is usually adjustable to adapt to different lighting environments.

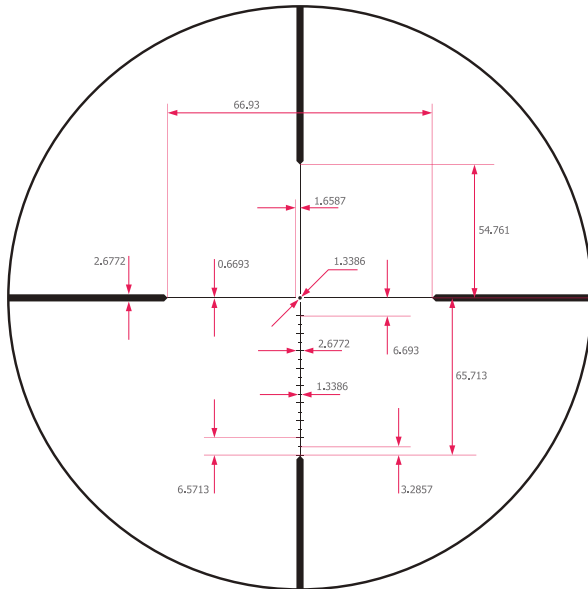

3-18x56 PRO Reticle

Caution: Be sure that your firearm is unloaded and pointed in a safe direction. Always practice safe firearms handling procedures.

It is best that you first loosen all the upper scope ring screws to help with mounting the scope onto your optics rail on your firearm. This will allow you to space out the rings properly, for the ring mounting bolts to match up with the cross slots of the optics rail.

Once you have the scope rings mounted onto your optics rail, you will next have to move the scope forwards or rearwards to adjust the scopes position to allow for maximum eye relief and reticle leveling. Slide the scope as far forward as possible in the rings.

While viewing through the scope in a normal shooting position move the scope back towards your eye until a full field of view is achieved while ensuring that the scope will be a safe distance from your eye when the firearm recoils.

Without disturbing the eye relief setting, aim the reticle at a plumb line. Align the vertical crosshair of the reticle with the plumb line by rotating the scope within the rings.

Once you are satisfied with your scope's settings and placement, tighten the ring screws evenly to approximately 10 to 15 inch-pounds of torque (not foot-pounds) using an inch-pound torque wrench/screwdriver.

Be sure not to over-tighten the rings, as doing so can cause permanent damage to the scope.

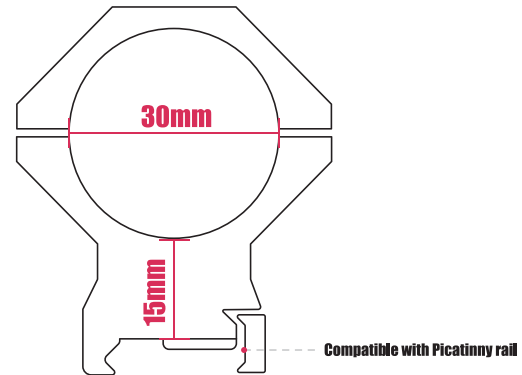

## 7

### FOCUSING YOUR SCOPE

**Caution:** Viewing the sun with this scope or any other optical device can cause permanent injury to the eye including blindness.

This scope has a quick focus ring feature. Holding the scope at the proper distance from your eye, in order to achieve a Full Field of View the reticle should appear sharp and clear.

If not, it will be necessary to adjust the focus by turning the Quick Focus Ring.

1. Make quick glances through the eyepiece at a featureless bright surface such as a white wall, or the open sky.
2. Turning the Quick Focus Ring Counter-Clockwise will extend the Ocular Lens outward, generally suitable for those who are far sighted. Turning the Quick Focus Ring Clockwise will draw the Ocular Lens inward, generally suitable for those who are near sighted.
3. Fine tune your adjustments until the reticle appears sharp and clear. If the Ocular Lens reaches its outer limits of adjustment, be sure not to force it as doing so will cause damage to the eyepiece.

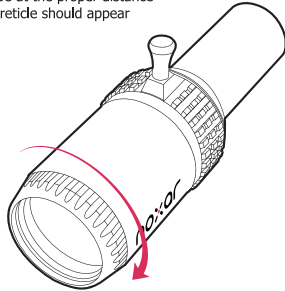

## 8

### ADJUSTABLE PARALLAX KNOB

The adjustable parallax knob in this model allows for precise adjustment of the reticle parallax to the target observed through the scope.

If the parallax is not properly adjusted, the reticle will appear to shift or move relative to the target when you hold the scope perfectly still and move your head around the eyepiece lens.

Place the scope on a stable setup/platform and observe the target through the scope. While moving your head around the eyepiece lens as you look through the scope, adjust the parallax knob in either direction until the reticle remains perfectly still on the observed target.

With proper adjustment, the reticle should remain perfectly stationary on the target, as if it were painted on it. Adjusting the parallax in this way will help achieve more precise and accurate shots at longer distances and maintain consistent shot groupings.

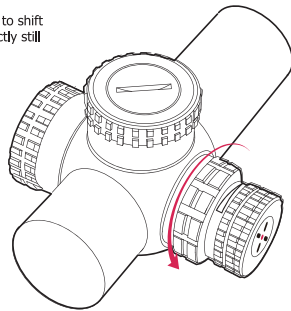

## 9

### WINDAGE AND ELEVATION ADJUSTMENT TURRETS

Your scope is equipped with Elevation and Windage Adjustment Turret which change your scopes point of aim relative to the bullet point of impact on target for a specific range.

The Elevation Adjustment Turret is located on top of the Turret Body, and is responsible for the Up and Down movement of the reticle.

The Windage Adjustment Turret is located on the right side of the Turret Body. And is responsible for the Left and Right movement of the of the reticle.

To access the Adjustment Turret simply twist the protective Turret Caps off Counter-Clockwise.

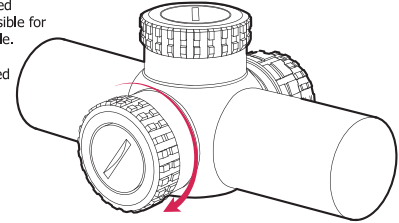

On the top of each Adjustment Turret you will notice that there are arrows indicating direction of movement.





Turning the Elevation Adjustment Turret Counter-Clockwise will move the reticle Down in the scope shifting the bullet point of impact Up.

Turning Elevation Adjustment Turret Clockwise will move the reticle in the scope Up, shifting the bullet point of impact Down.

Turning Windage Adjustment Turret Counter-Clockwise will move the reticle Left in the scope, shifting the bullet point of impact Right.

Turning Windage Adjustment Turret Clockwise will move the reticle in the scope Right, shifting the bullet point of impact Left.

The Elevation and Windage Adjustment Turret also feature audible and tactile clicks which you can hear or feel the adjustments. Each click moves the reticle point of aim 1/2 MOA\* at 100 Yards. The chart below represents the amount of movement of each click at various distances.

ELEVATION ADJUSTMENT		WINDAGE ADJUSTMENT	
UP*	CLOCKWISE 	LEFT*	COUNTER CLOCKWISE 
DOWN*	COUNTER CLOCKWISE 	RIGHT*	CLOCKWISE 

\*POINT OF IMPACT

\*POINT OF IMPACT

## 10 ZEROING YOUR SCOPE

After you have completed the installation of your scope it will be necessary to adjust the scopes point of aim to match the bullet's point of impact on a target. This can be accomplished using several methods we recommend the use of a Bore Sighting device to save time and ammunition.

Using a Bore Sighting device will ensure that your shots land "on paper". Follow the Manufacturer's Instructions for the Bore Sighting device that you choose in order to achieve the best results.

You are now ready to finalize your Zero.

**Caution:** always be sure to remove the bore sighting device before shooting live ammunition, failure to do so can cause damage to your firearm or injury to yourself and those around you.

**Caution:** when operating any type of firearm always use proper eye and ear protection, be sure to use your firearm in an area that is permissible under local, state, and federal law.

Bore Sighting alone is not sufficient enough to ensure an accurate Zero. You must shoot your firearm at the range in order to confirm an accurate Zero. Follow these steps to fine tune your scope adjustments:

1. Secure your firearm using a steady platform such as a bench rest or sand bags.
2. Fire 3 to 5 carefully aimed shots at a target that is set to your desired Zeroing distance. (starting at 50 or 100 yards is recommended)
3. Observe where the bullets have struck the target and make adjustments to the Elevation and Windage settings as necessary until your point of aim matches your point of impact.
4. Continue with this process until you have achieved your desired level of accuracy.

## 11 BATTERY

**Locate the battery compartment:** The battery compartment is on the side of the scope.

**Open the battery cap:** No tools are needed. Simply rotate the cap counterclockwise with your hand to open it.

**Insert the battery:** Place the CR2032 battery with the positive side (marked with a "+") facing up into the compartment.

**Close the battery cap:** Rotate the cap clockwise until it is securely tightened.

**Check functionality:** After installing the battery, turn on the scope and make sure the red dot or other reticle functions are working properly.

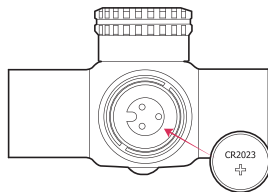

## 12 CARE AND MAINTENANCE

Your NOXAR series scope is shock, fog and water proof. However, you should never try to take it apart or clean it internally. The exposed optical lens surfaces will perform their best if they are routinely cleaned with a lens brush or a lens cloth.

For a deep cleaning, you can also use high grade camera lens paper and camera lens cleaning solutions. Never use any other type of materials or solvents other than those designed specifically for optical lenses to avoid damaging your scope. Clean the outer portion of the lens cavity first with cotton swabs, clearing as much debris and dust as possible. Then, gently clean the lenses using a circular motion starting in the center and ending at the edges.

Do not rub the lenses continually simply wipe in short circular patterns. Maintain the exterior surfaces of the scope by removing dirt or sand by using a soft brush or a soft, dry cloth. It is not necessary to lubricate any part of the scope as all of the moving parts, such as the turrets and the quick focus eye, are permanently lubricated.

## 13 BALLISTIC TURRET

The ballistic turret features pre-calibrated range markings. Simply rotate the dial to the corresponding distance setting to automatically compensate for bullet drop via reticle adjustment. This eliminates the need for manual trajectory calculation required with standard turrets when engaging targets at varying distances, enabling rapid target acquisition across different ranges.

### Installation steps

1. Rotate the fixing screw on top of the turret counterclockwise and remove it.
2. Lift upward to remove the standard turret. (ensure the zero stop is engaged when removing).
3. Install the limit ring and ballistic turret base. (the limit ring restricts the adjustment range of the ballistic turret to a specific scope. To increase the range, the limit ring may be omitted).
4. Install the dial ring according to your needs.
5. Secure the fixing screw by rotating it clockwise.

